

## A2P BP1



### Début de commercialisation: 2007

- Serrure type Fortissime T A2P\*\*\* sans entrebâilleur (4 crochets basculants) + pêne ½ tour + double pêne central
- Cylindre monobloc à lanterne
- UNIQUEMENT sans vitrage.**

### Hauteur porte: (M)

- De 1950 à 2335 mm suivant type de prébâti

### Largeur porte: (B)

- De 750 à 1125 mm suivant types de prébâti

### Main et sens:

- à Droite ou à Gauche en tirant

### Divers:

- 3 Paumelles de 140 mm + 3 pannetons coniques Ø 15mm.
- Couleur bâti et vantail: **Blanc RAL 1013, Blanc cassé RAL 9010, Marron RAL 8014, Bleu RAL 5010, Bordeaux RAL 3004, Vert RAL 6005, Bleu saphir RAL 5003, Bleu gris RAL 5008, Gris béton RAL 7023, Gris bleu RAL 7031, Gris clair RAL 7035, Vert pâle RAL 6021, Gris RAL 7016, Noir RAL 9005** ou à peindre.
- Le bâti est de la couleur de la face du vantail (au choix sur chaque face)
- Version avec moulures ou sans moulures.
- Microviseur en option

## FORSTYL "His"



**Bâtis:**

4 faces épaisseur 20/10è avec barre de seuil aluminium anodisé ton naturel 20mm ou balai automatique

**Vantail:** Composition d'un vantail  
de l'extérieur vers l'intérieur

- décor extérieur 15/10è aluminium thermo laqué époxy
- isolant extérieur 6mm polystyrène expansé
- une tôle acier 20/10è, sur laquelle sont soudées la poutre serrure, la ligne arrière (paumelles + pannetons anti-dégondage) une traverse haute et une traverse basse
- isolant intérieur 50mm polystyrène extrudé
- tôle intérieur 8/10è acier électrozingué
- décor intérieur 15/10è aluminium thermo laqué epoxy

**Serrure:**

Serrure de type Fortissime T 4 pènes crochets basculants

**FORSTYL "His"**

**PRÉBATIS DISPONIBLES**

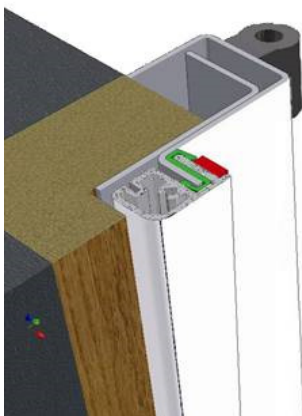

<b>2ème monte</b>
Largeur ( <b>B</b> ) Mini / Maxi 750mm / 1050mm
Hauteur ( <b>M</b> ) Mini / Maxi 1950mm / 2300mm
Feuilleure ( <b>F</b> ) Mini / Maxi 25 mm / 45 mm

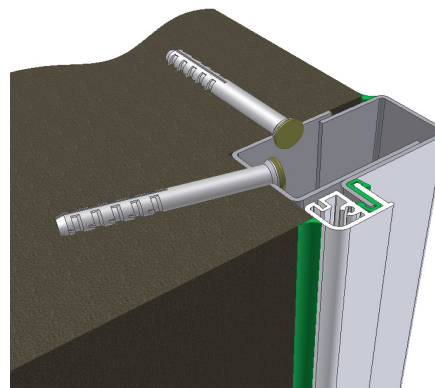

<b>tubulaire / à sceller</b>
Largeur ( <b>B</b> ) Mini / Maxi 830mm / 1125mm
Hauteur ( <b>M</b> ) Mini / Maxi 1990mm / 2335mm

# FORSTYL "His"

Cylindre de remplacement 3\*

## PIECES DETACHEES

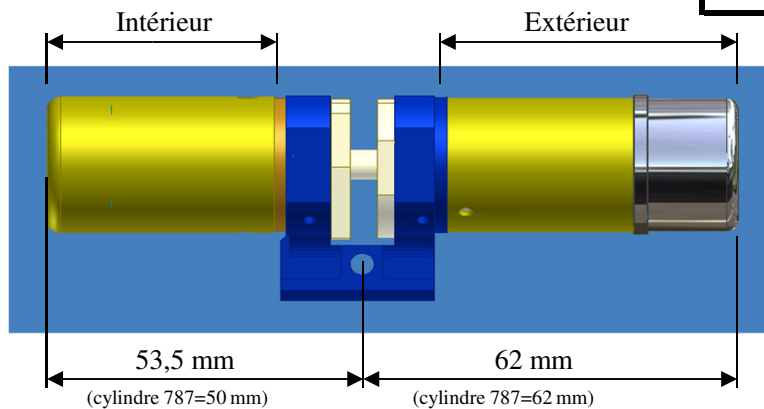

**Joint Tubulaire Vantail (7m)**

70406400

**Joint bâti mousse (6m)**

70406800

**Joint bâti lèvres (6m)**

72453800

**Axes à billes + vis réglage (X 3)**

72452500

F3D doré: 75050720 787 Z doré: 75007720  
 F3D chromé: 75050730 787 Z chromé: 75007730

**Microviseur**



Doré 73171020

Chromé 73171080

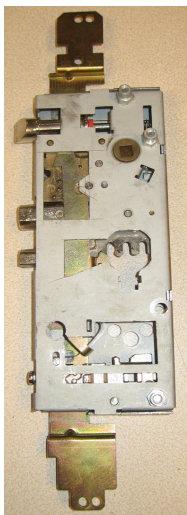

**MBL**

Droite: 72454203

Gauche: 72454204

**Carré à bascule (X 5)**

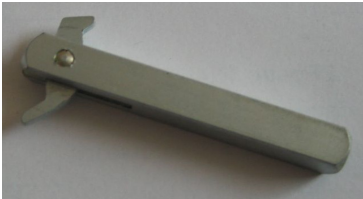

70499250

**FORSTYL "His"**

**PIECES DETACHEES**

**Cache paumelles (X 6)**

<b>Blanc Ral 1013</b>	<b>Bleu Ral 5010</b>
72452600	72452650
<b>Blanc Ral 9010</b>	<b>Bleu saphir Ral 5003</b>
72452610	72452630
<b>Marron Ral 8014</b>	<b>Bleu gris Ral 5008</b>
72452620	72452640
<b>Bordeaux Ral 3004</b>	<b>Gris béton Ral 7023</b>
72452660	72452680
<b>Vert Ral 6005</b>	<b>Gris bleu Ral 7031</b>
72452670	72452690
<b>Vert pâle Ral 6021</b>	<b>Gris clair Ral 7035</b>
72452700	72452590

**Fourreaux**



<b>Doré</b>	70413720
<b>Chromé</b>	70413780



## FORSTYL "His"

### VERSIONS DISPONIBLES UNIQUEMENT SANS VITRAGE

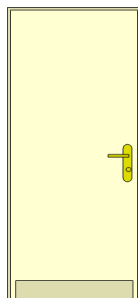

Version 0

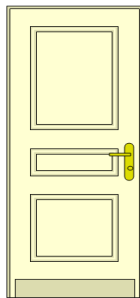

Version 1

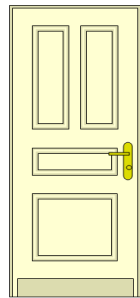

Version 2

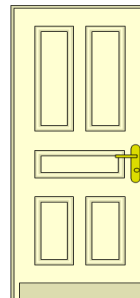

Version 3

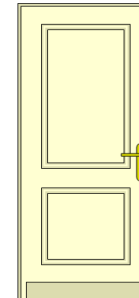

Version 4

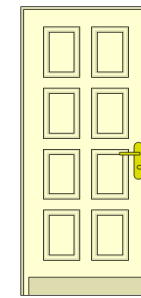

Version 5

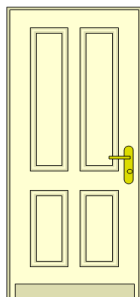

Version 6

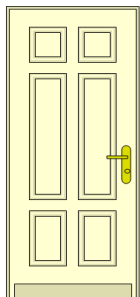

Version 7

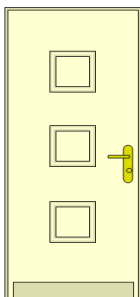

Version 9

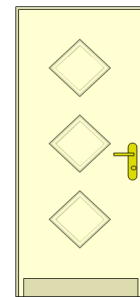

Version 10

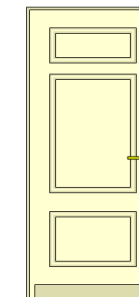

Version 11

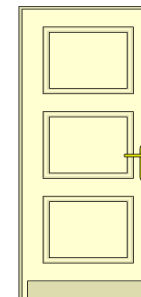

Version 12

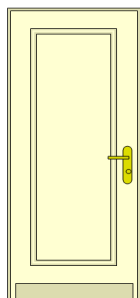

Version 13

**FORSTYL "His"**

**Couleurs**

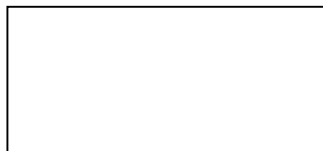

**Blanc RAL 9010**

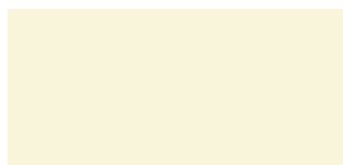

**Blanc cassé RAL 1013**



**Marron RAL 8014**



**Bleu RAL 5010**

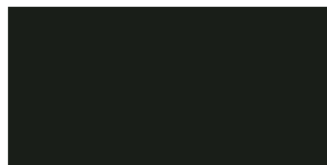

**Vert RAL 6005**



**Bleu saphir RAL 5003**



**Bleu gris RAL 5008**



**Bordeaux RAL 3004**

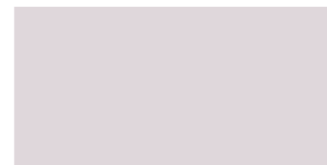

**Gris clair RAL 7035**



**Vert pâle RAL 6021**



**Gris bleu RAL 7031**



**Gris béton RAL 7023**

**FORSTYL His ÉQUIPEMENTS Gamme Classique**

1/2 ensemble **MOBILE** intérieur



**Doré**  
72411100

**Chromé**  
72411130

1/2 ensemble **FIXE** Extérieur Pommeau central



**Doré**  
72417640

**Chromé**  
72417680

1/2 ensemble **FIXE** Extérieur Bouton



**Doré** 72412100

**Chromé** 72412130



1/2 ensemble **FIXE** Extérieur Aileron



**Doré** 72412200

**Chromé** 72412230



1/2 ensemble **MOBILE** Extérieur



**Doré**      **Droite** 72412303  
                 **Gauche** 72412304

**Chromé**    **Droite** 72412333  
                 **Gauche** 72412334





**ÉQUIPEMENTS**

**1/2 ensemble FIXE Extérieur Pommeau central**



**Doré**  
72417640

**Chromé**  
72417680

**Poignée de tirage**



**Doré**            72417440

**Chromé**        72417480

#### 1/2 ensemble MOBILE intérieur



<b>Blanc Ral 1013</b>	72411340	<b>Bleu Ral 5010</b>	72411370
<b>Blanc Ral 9010</b>	72411310	<b>Bleu saphir Ral 5003</b>	72411380
<b>Marron Ral 8014</b>	72411390	<b>Bleu gris Ral 5008</b>	72411350
<b>Bordeaux Ral 3004</b>	72411320	<b>Gris béton Ral 7023</b>	72401350
<b>Vert Ral 6005</b>	72411360	<b>Gris bleu Ral 7031</b>	72411330
<b>Vert pâle Ral 6021</b>	72401360	<b>Gris clair Ral 7035</b>	72411300

#### 1/2 ensemble FIXE Extérieur Bouton



<b>Blanc Ral 1013</b>	72422140	<b>Bleu Ral 5010</b>	72422170
<b>Blanc Ral 9010</b>	72422110	<b>Bleu saphir Ral 5003</b>	72422180
<b>Marron Ral 8014</b>	72422190	<b>Bleu gris Ral 5008</b>	72422150
<b>Bordeaux Ral 3004</b>	72422120	<b>Gris béton Ral 7023</b>	72402150
<b>Vert Ral 6005</b>	72422160	<b>Gris bleu Ral 7031</b>	72422130
<b>Vert pâle Ral 6021</b>	72402160	<b>Gris clair Ral 7035</b>	72422100

#### 1/2 ensemble FIXE Extérieur Aileron



<b>Blanc Ral 1013</b>	72422240	<b>Bleu Ral 5010</b>	72422270
<b>Blanc Ral 9010</b>	72422210	<b>Bleu saphir Ral 5003</b>	72422280
<b>Marron Ral 8014</b>	72422290	<b>Bleu gris Ral 5008</b>	72422250
<b>Bordeaux Ral 3004</b>	72422220	<b>Gris béton Ral 7023</b>	72402250
<b>Vert Ral 6005</b>	72422260	<b>Gris bleu Ral 7031</b>	72422230
<b>Vert pâle Ral 6021</b>	72402260	<b>Gris clair Ral 7035</b>	72422200

#### 1/2 ensemble MOBILE Extérieur



<b>Blanc Ral 1013</b>		<b>Bleu Ral 5010</b>	
Droite	72422343	Droite	72422373
Gauche	72422344	Gauche	72422374
<b>Blanc Ral 9010</b>		<b>Bleu saphir Ral 5003</b>	
Droite	72422313	Droite	72422383
Gauche	72422314	Gauche	72422384
<b>Marron Ral 8014</b>		<b>Bleu gris Ral 5008</b>	
Droite	72422393	Droite	72422353
Gauche	72422394	Gauche	72422354
<b>Bordeaux Ral 3004</b>		<b>Gris béton Ral 7023</b>	
Droite	72422323	Droite	72402353
Gauche	72422324	Gauche	72402354
<b>Vert Ral 6005</b>		<b>Gris bleu Ral 7031</b>	
Droite	72422363	Droite	72422333
Gauche	72422364	Gauche	72422334
<b>Vert pâle Ral 6021</b>		<b>Gris clair Ral 7035</b>	
Droite	72402363	Droite	72422303
Gauche	72402364	Gauche	72422304

## FORSTYL "His" 2ème Monte

Déterminer les cotes B et M: Les cotes sont à relever en fond de feuillure, en mm

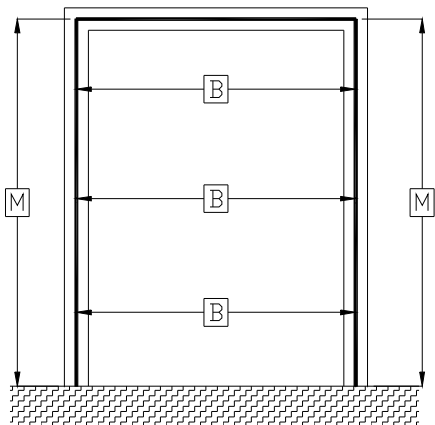

- Retenir les cotes:

(B): minimum

(M): minimum

et arrondir à une cote inférieure se terminant par 0 ou 5

Exemples:

B minimum = 934, arrondir à 930 ou 925

M minimum = 2044, arrondir à 2040 ou 2035

(suivant l'état du bâti existant)

(suivant l'état du bâti existant)

- La cote (F) correspond au fond de feuillure

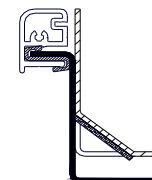

2ème monte

**Porter ces valeurs arrondies B et M, ainsi que la valeur F excate sur le bon de commande**

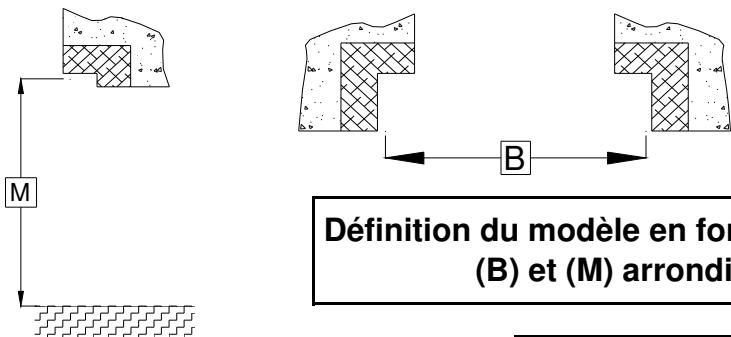

**Définition du modèle en fonction des valeurs (B) et (M) arrondies et (F)**

	MINI	MAXI
Largeur B	750	1050
Hauteur M	1950	2300
Profondeur F	25	45

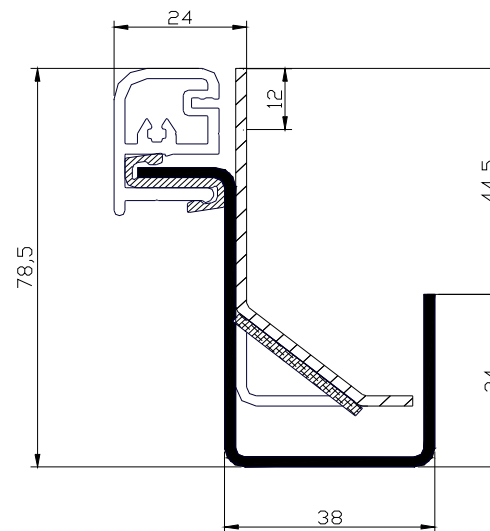

## FORSTYL "His" Tubulaire

Déterminer les cotes B et M: Les cotes sont à relever en fond de feuillure, en mm

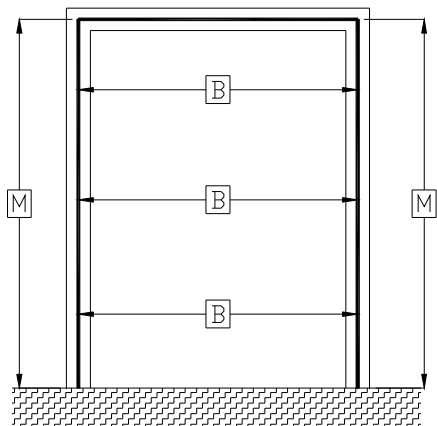

- Retenir les cotes:

**(B): minimum**

**(M): minimum**

et arrondir à une cote inférieure se terminant par 0 ou 5

**Exemples:**

**B minimum = 934, arrondir à 930 ou 925**

**M minimum = 2044, arrondir à 2040 ou 2035**

(suivant l'état du bâti existant)

(suivant l'état du bâti existant)

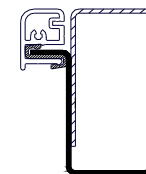

Tubulaire

**Porter ces valeurs arrondies (B et M) sur le bon de commande**

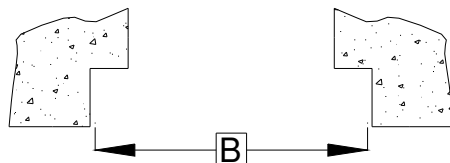
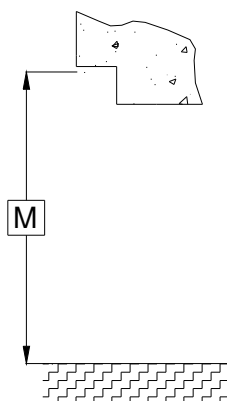

**Définition du modèle en fonction des valeurs (B) et (M) arrondies**

	MINI	MAXI
<b>Largeur B</b>	830	1125
<b>Hauteur M</b>	1990	2335

